

The Kumud is Esthetica's foot reflexology sofa — a clean, elegantly designed chair built for pedicure and foot massage treatments in professional spa environments. Its simple, considered silhouette combines wooden armrests and a wooden base with a multi-density foam cushion and detachable seat cushion, delivering a comfortable, well-supported seating experience across every session. The electronically controlled backrest reclines and inclines smoothly via a 6000N Dewert Okin actuator, operated through a handheld remote — keeping guests at ease without interrupting the treatment. Supplied with 2 ottomans, the Kumud is a practical, refined solution for any spa reflexology area.

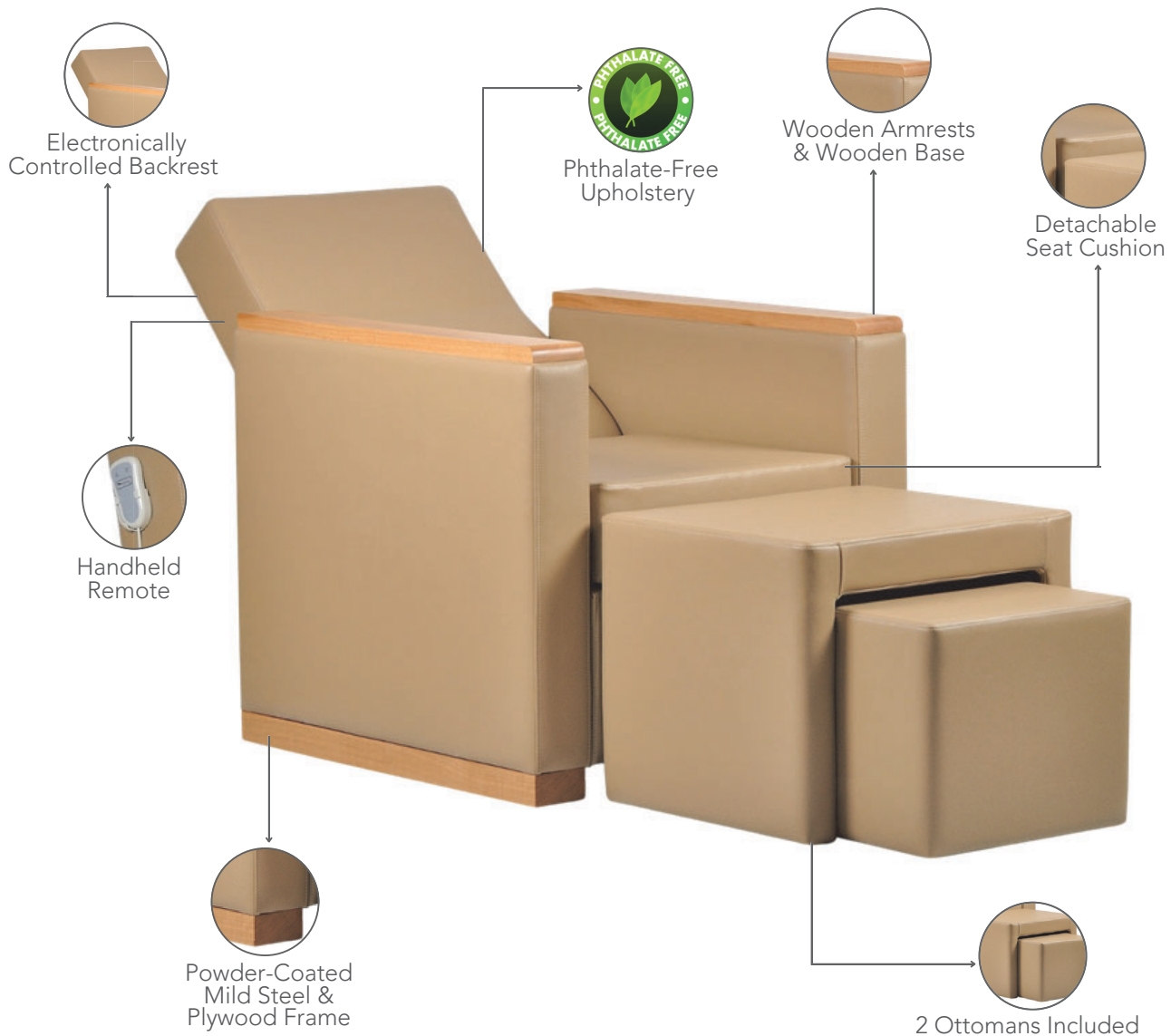

KEY FEATURES



Electronically Controlled Backrest

The Kumud's backrest is electronically controlled via a Dewert Okin 6000N actuator, adjustable through a handheld remote — allowing guests to recline or incline smoothly to their preferred position without any disruption to the treatment in progress.

Detachable Seat Cushion

The Kumud features a detachable seat cushion that can be removed for easy cleaning and replacement — a practical detail that makes maintenance straightforward in a busy commercial spa environment.

Wooden Armrests & Wooden Base

The Kumud's natural wooden armrests and base bring a warm, refined aesthetic to any reflexology area — combining the durability of a powder-coated steel and plywood frame with the visual warmth of natural wood detailing.

Phthalate-Free Upholstery

The Kumud is upholstered in phthalate-free fabric designed for professional spa environments — safe, durable, and built for the demands of daily commercial use, with antibacterial, fire retardant, and stain resistant properties as standard.

FEATURES

Backrest	Electronically Recline & Incline
Armrest	Wooden Armrest and Wooden Base
Seat	Detachable Cushion
Foam Cushion	Multi-Density Foam Cushion
Motor	Dewert Okin 6000N Actuator
Additional	2 Ottomans Included

TECHNICAL SPECIFICATIONS

Length	2025 mm / 79.2 in
Width	750 mm / 29.5 in
Minimum Height	765 mm / 30 in
Maximum Height	990 mm / 38.9 in
OTTOMANS	
Width	540 mm / 21.2 in & 400 mm / 15.7 in
Height	410 mm / 16 in & 340 mm / 13.3 in

ELECTRICAL PARAMETERS

Power in (Mains Power Supply)	100–240V, 50–60Hz, 3A
IPX Rating	IPX6
Operating Temperature	10–40°C
Shock Protection:	Class I

BASE & FRAME

Base	Powder-Coated Mild Steel & Plywood Frame
Load Bearing capacity	150 kgs

SAFETY STANDARDS

General Safety Standards	IEC 60601-1
EMI/EMC	IEC 60601-2

UPHOLSTERY

Type	Phthalate-Free Upholstery
Thickness	1.01 mm
Tensile Strength	ISO 1421, 804 N/ 5 cm
Colour Options	Cream, Beige, Mouse Grey, Brown
Weight	732 g / sqmt
Abrasion	ISO 5470-2 = 2,00,000 cycles / min

WARRANTY

Motors	2 years
Frame	5 years

TECHNICAL DRAWINGS

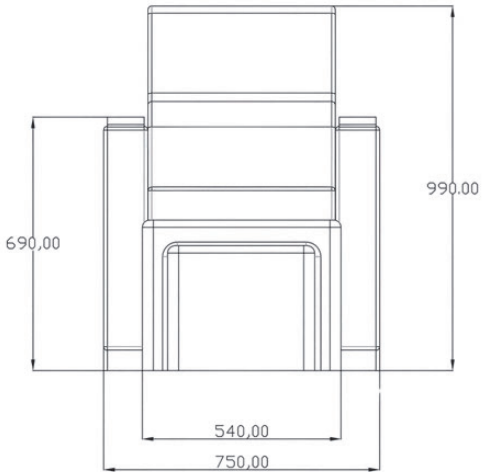

TOP VIEW (IN CHAIR POSITION)

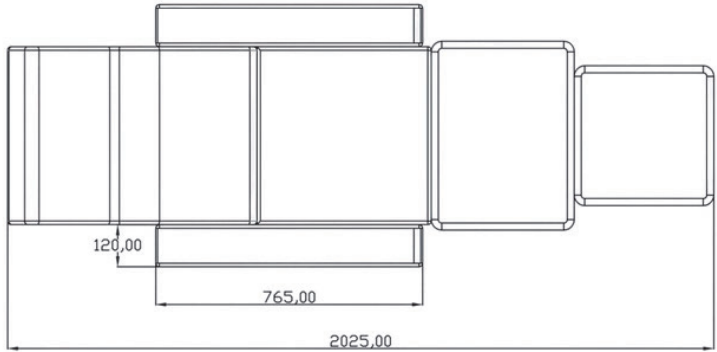

TOP VIEW (IN RECLINE BACKREST POSITION)

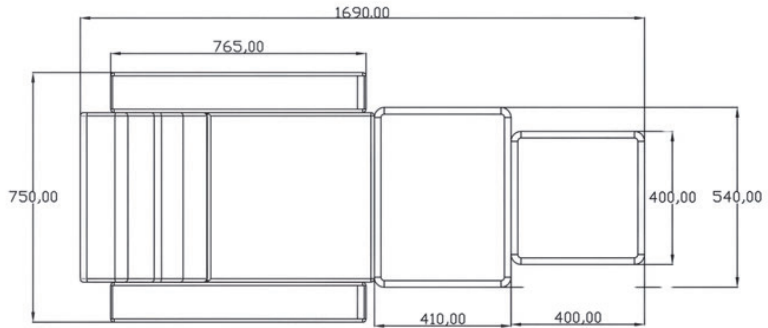

TOP VIEW (IN INCLINE BACKREST POSITION)

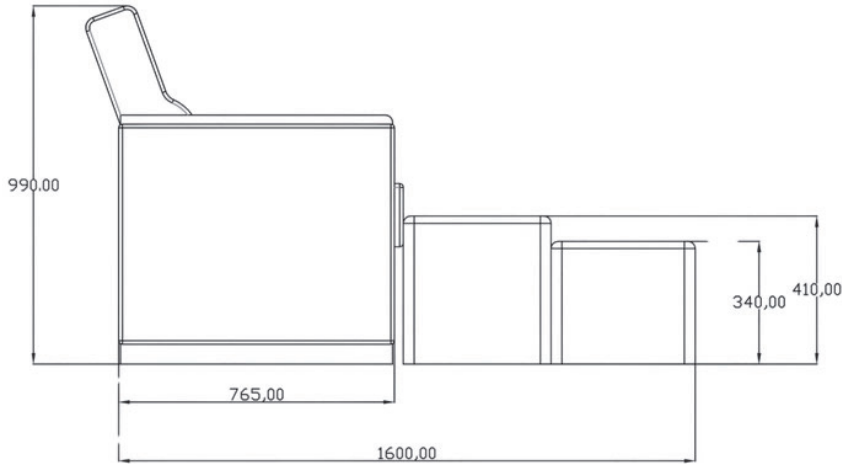

MAXIMUM HEIGHT

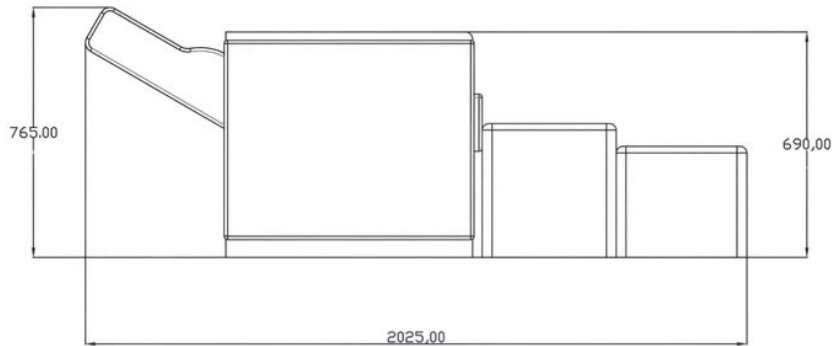

MINIMUM HEIGHT

ALL DIMENSIONS ARE IN MM

WOOD FINISH OPTIONS

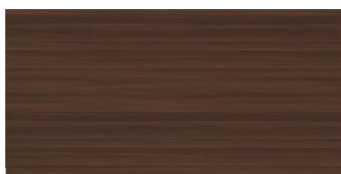

American Oak
Dark Walnut

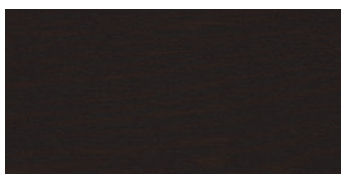

American Oak
Wenge



American Oak
Yellow Teak



American Oak
White Wash Finish

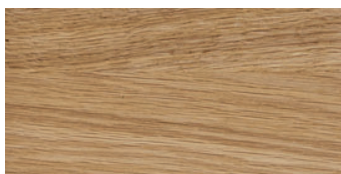

American Oak
Water Base



American Oak
PU Finish

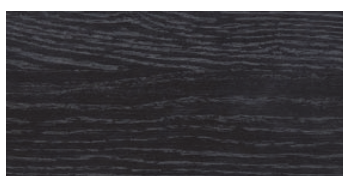

American Oak
Open Pore Black



American Oak
Open Pore White

PHTHALATE-FREE UPHOLSTERY

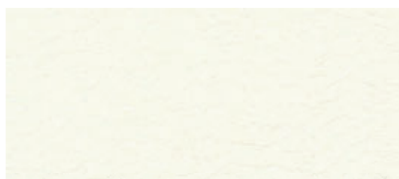

Cream

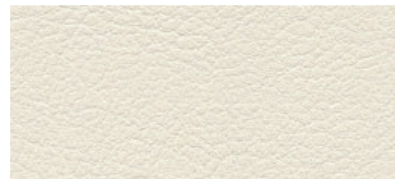

Beige

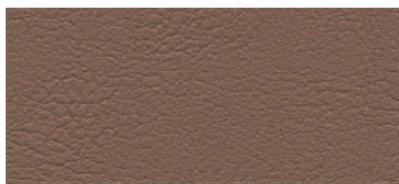

Brown

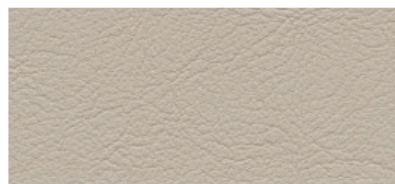

Mouse Grey