

The Mahit is Esthetica's premium four-motor electric treatment table, built for hotel and resort spas. Electronic adjustments for the backrest, legrest, height, Trendelenburg, and reverse Trendelenburg put complete control at the therapist's fingertips. Gas spring-assisted armrests that lower and swing sideways, a manually adjustable headrest, and a detachable footrest give therapists the freedom to work with precision across massages, facials, pedicures, and foot treatments — making the Mahit as versatile as it is refined.



KEY FEATURES



Manually Adjustable Headrest

The Mahit's headrest can be manually angled to suit the client's position and treatment requirements, adding comfort and flexibility across a wide range of services — from massages to facials.

Programmable Handset with End-of-Treatment Position

The Mahit's programmable handset stores therapist-defined positions that can be recalled with a single touch. The End-of-Treatment function returns the bed to a pre-set position at the close of every session — saving time and ensuring a seamless, consistent guest experience.

Lowerable & Swing-Away Armrests

Gas spring-assisted armrests can be lowered and swung sideways, giving therapists unrestricted access during full-body treatments while ensuring guests remain in a natural, comfortable position throughout.

Veridura Phthalate-Free Upholstery

The Mahit is available in Veridura Phthalate-Free Upholstery, designed for professional spa environments, offering a safer surface for both clients and therapists. It resists stains, acetone, and disinfectants, withstands frequent cleaning, and ensures durable, fire- and abrasion-resistant performance.

FEATURES

Armrests
Backrest
Headrest
Legrest
Height
Trendelenburg Operation
Foam Cushion
Optional

Programable Handset

Gas spring assisted lowerable arm rest that can be swing side ways
Electronically Adjustable
Headrest can be manually angled
Electronically Adjustable
Electronically Adjustable
Electronically adjustable trendelenburg and reverse trendelenburg
161 mm mixed layer of different densities for comfortable massage experience
IVC Heating Technology



TECHNICAL SPECIFICATIONS

Length 2100 mm / 82.6 in
Width 790 mm / 31 in
Minimum height 640 mm / 25 in
Maximum height 1030 mm / 40.5 in
Tilt angle 13°

ELECTRICAL PARAMETERS

Power in (Mains Power Supply) 100–240V, 50–60Hz, 3A
IPX Rating IPX6
Operating Temperature 10–40°C
Shock Protection: Class I

BASE & FRAME

Base Powder-coated mild steel frame
Safe Working Load 250 kgs
Load Bearing capacity 180 kgs

SAFETY STANDARDS

General Safety Standards IEC 60601-1
EMI/EMC IEC 60601-2

UPHOLSTERY

Type Veridura Phthalate-Free Upholstery
Thickness 1 mm
Tensile Strength ISO 1421, 869.22 N/ 5 cm
Colour Options Cream, Beige, Mouse Grey, Brown, Charcoal Grey
Weight 726.7 g / sqmt
Abrasion ISO 5470-2 = 2,00,000 cycles / min

WARRANTY

Motors 2 years
Frame 5 years

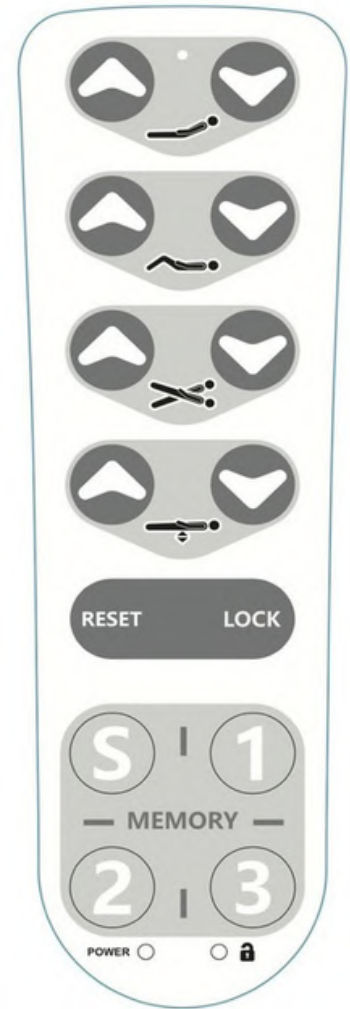

HANDSET

TECHNICAL DRAWINGS



TOP VIEW

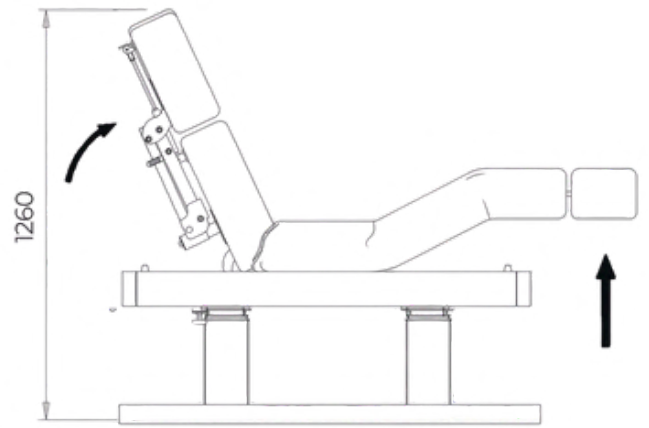

SIDE VIEW

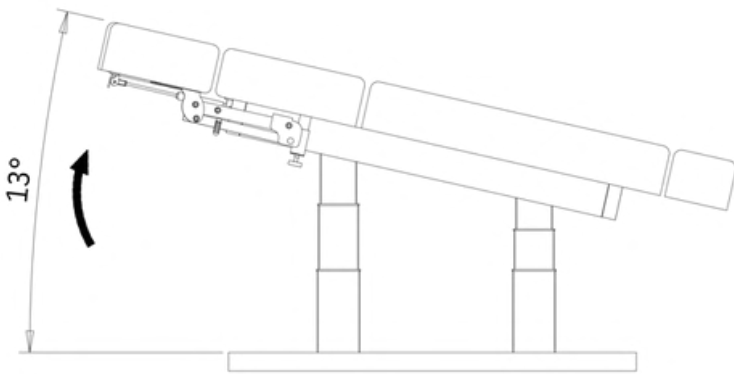

TRENDELENBURG (HEAD SIDE UP)

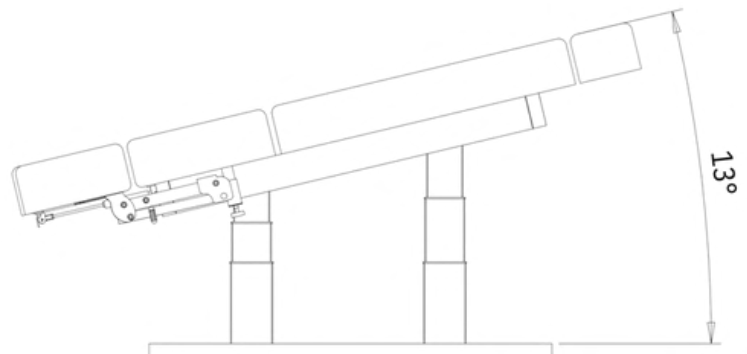

TRENDELENBURG (LEG SIDE UP)

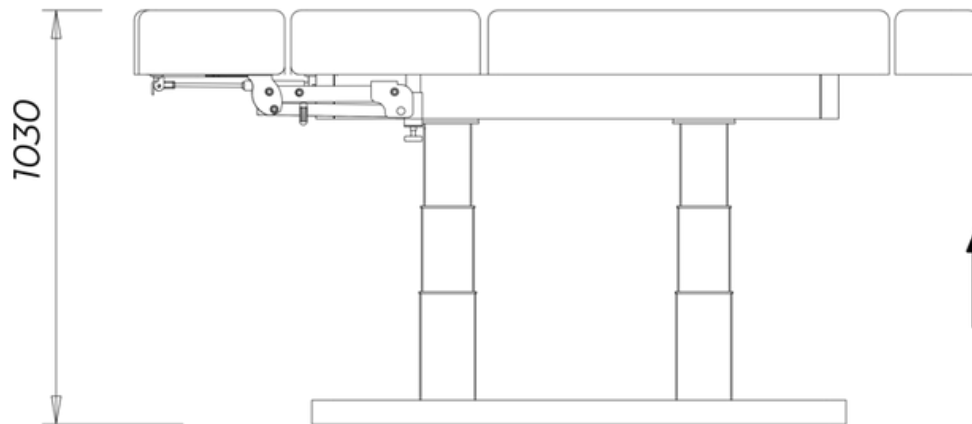

MAXIMUM HEIGHT

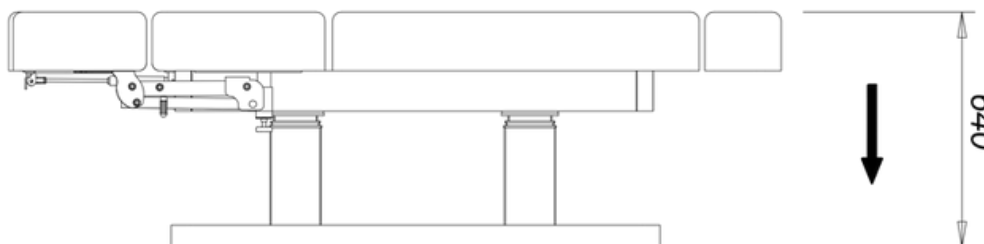

MINIMUM HEIGHT

ALL DIMENSIONS ARE IN MM

WOOD FINISH OPTIONS

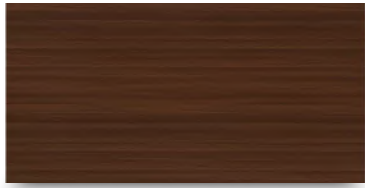

American Oak
Dark Walnut



American Oak
Wenge

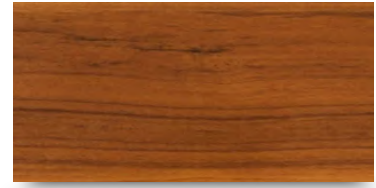

American Oak
Yellow Teak



American Oak
White Wash Finish



American Oak
Water Base



American Oak
PU Finish



American Oak
Open Pore Black

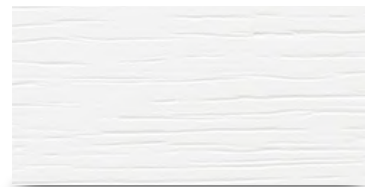

American Oak
Open Pore White

VERIDURA PHTHALATE-FREE UPHOLSTERY

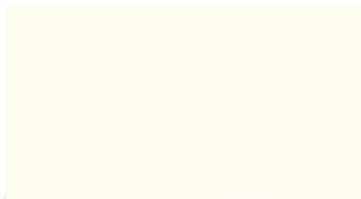

Cream

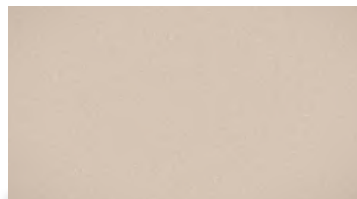

Beige



Mouse Grey



Brown



Charcoal Grey



Phthalate-Free



Fire Retardant



Oil Resistant



Alcohol Resistant



Ultra Soft



Stain Resistant



Anti Bacterial



Eco - Friendly