

The Marut is Esthetica's premium four-motor electric treatment table, built for the demands of hotel and resort spas. Electronic adjustments for the backrest, legrest, height, Trendelenburg, and reverse Trendelenburg put complete control at the therapist's fingertips. Gas spring-assisted armrests that lower and swing sideways create the freedom to work with precision and ease, while a detachable footrest extends versatility to foot massage and pedicure treatments — making the Marut equally at home across every service on the spa menu.



# KEY FEATURES



## Memory Positioning

The Marut's programmable handset stores therapist-defined positions that can be recalled with a single touch, saving time between treatments and allowing therapists to maintain consistency across every session.

## Lowerable & Swing-Away Armrests

The Marut's gas spring-assisted armrests can be lowered and swung sideways, giving therapists unrestricted access during full-body treatments while ensuring guests remain in a natural, comfortable position throughout.

## Detachable Footrest

The Marut's detachable footrest enables flexible configurations to support a wider range of treatments — from full-body massage to dedicated foot care and pedicure services — with ease and convenience.

## Veridura Phthalate-Free Upholstery

The Marut is available in Veridura Phthalate-Free Upholstery, designed for professional spa environments, offering a safer surface for both clients and therapists. It resists stains, acetone, and disinfectants, withstands frequent cleaning, and ensures durable, fire- and abrasion-resistant performance.

## FEATURES

Armrests  
Headrest  
Backrest  
Legrest  
Height  
Trendelenburg Operation  
Foam Cushion  
Optional

Programable Handset

Gas spring assisted lowerable arm rest that can be swing side ways  
Detachable Headrest  
Electronically Adjustable  
Electronically Adjustable  
Electronically Adjustable  
Electronically adjustable trendelenburg and reverse trendelenburg  
161 mm mixed layer of different densities for comfortable massage experience  
IVC Heating Technology



## TECHNICAL SPECIFICATIONS

Length 2120 mm / 83 in  
Width 810 mm / 31.8 in  
Minimum height 640 mm / 25 in  
Maximum height 1030 mm / 40.5 in  
Tilt angle 13°

## ELECTRICAL PARAMETERS

Power in (Mains Power Supply) 100–240V, 50–60Hz, 3A  
IPX Rating IPX6  
Operating Temperature 10–40°C  
Shock Protection: Class I

## BASE & FRAME

Base Powder-coated mild steel frame  
Safe Working Load 250 kgs  
Load Bearing capacity 180 kgs

## SAFETY STANDARDS

General Safety Standards IEC 60601-1  
EMI/EMC IEC 60601-2

## UPHOLSTERY

Type Veridura Phthalate-Free Upholstery  
Thickness 1 mm  
Tensile Strength ISO 1421, 869.22 N/ 5 cm  
Colour Options Cream, Beige, Mouse Grey, Brown, Charcoal Grey  
Weight 726.7 g / sqmt  
Abrasion ISO 5470-2 = 2,00,000 cycles / min

## WARRANTY

Motors 2 years  
Frame 5 years

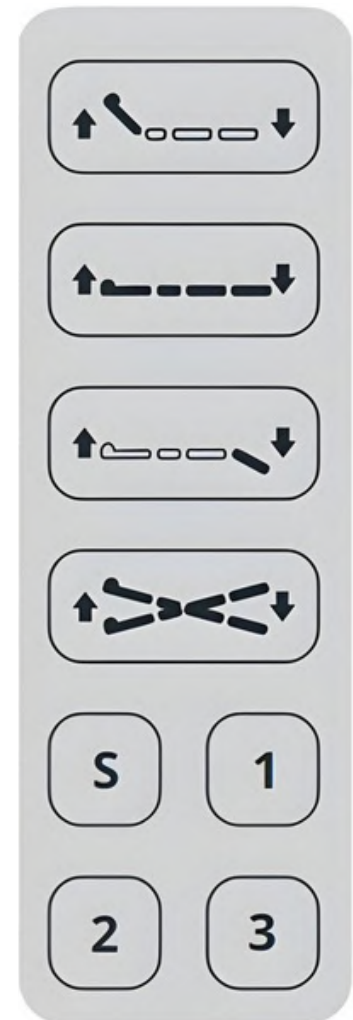

HANDSET

# TECHNICAL DRAWINGS



TOP VIEW

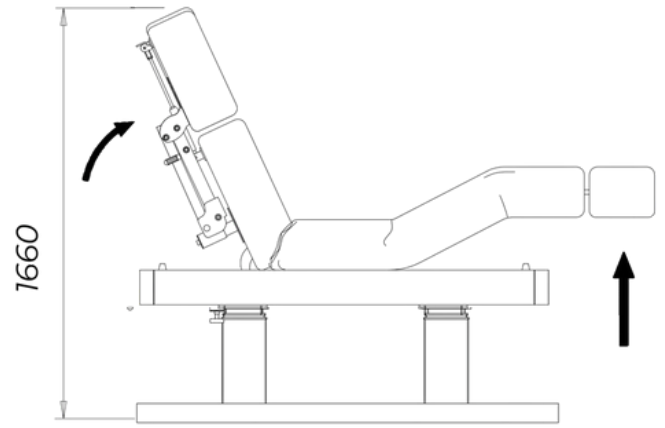

SIDE VIEW

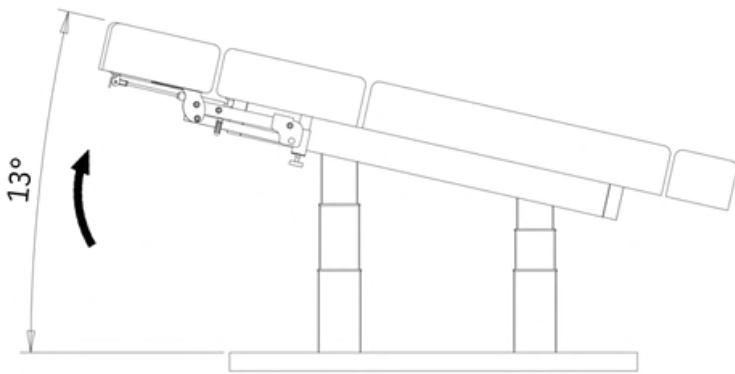

TRENDELENBURG (HEAD SIDE UP)

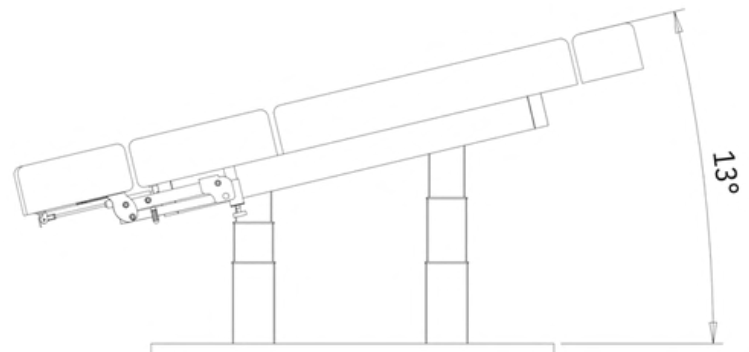

TRENDELENBURG (LEG SIDE UP)

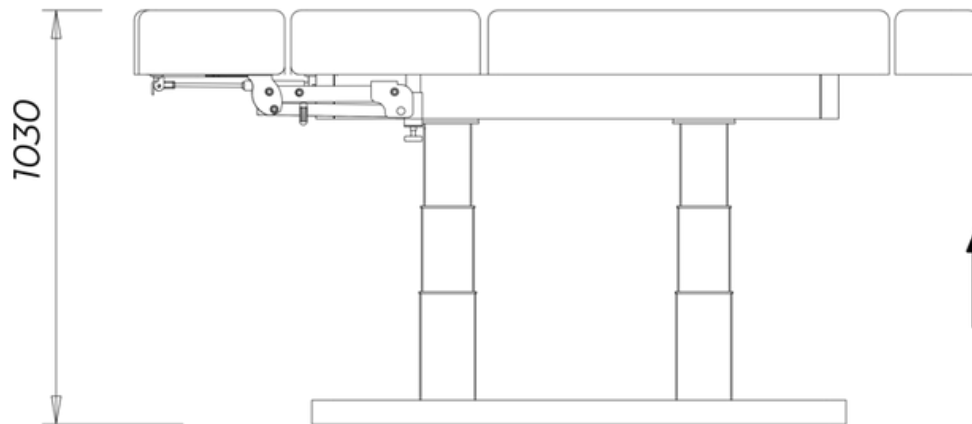

MAXIMUM HEIGHT

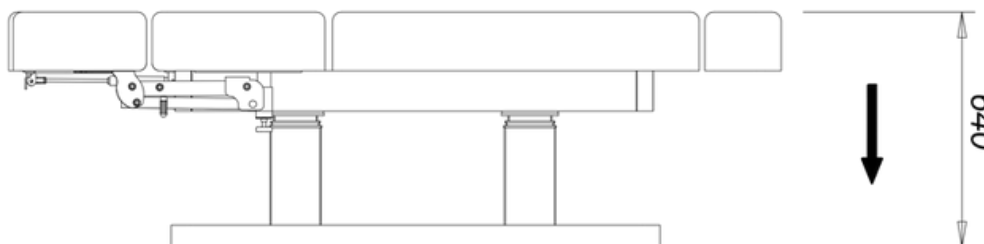

MINIMUM HEIGHT

ALL DIMENSIONS ARE IN MM

## WOOD FINISH OPTIONS

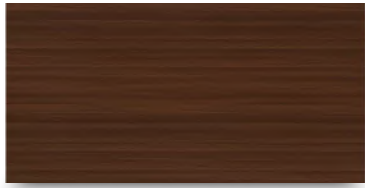

American Oak  
Dark Walnut



American Oak  
Wenge

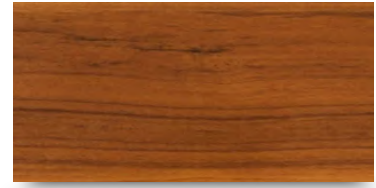

American Oak  
Yellow Teak



American Oak  
White Wash Finish



American Oak  
Water Base



American Oak  
PU Finish

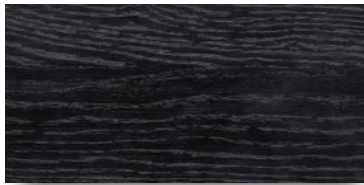

American Oak  
Open Pore Black

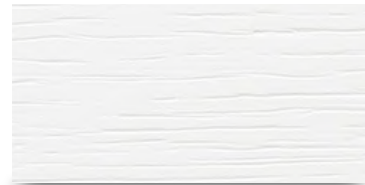

American Oak  
Open Pore White

## VERIDURA PHTHALATE-FREE UPHOLSTERY

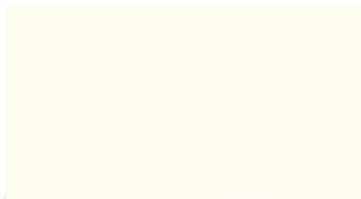

Cream

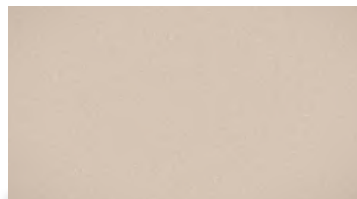

Beige



Mouse Grey

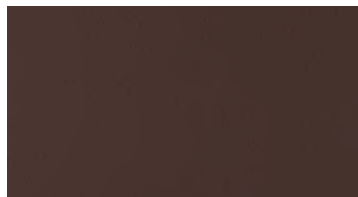

Brown



Charcoal Grey



Phthalate-Free



Fire Retardant



Oil Resistant



Alcohol Resistant



Ultra Soft



Stain Resistant



Anti Bacterial



Eco - Friendly