

The Zero Gravity Chair is Esthetica's electric recliner, designed to enhance spinal health, comfort, and deep relaxation in spa and wellness lounge environments. Built on the principle of neutral body posture, it gently decompresses the spinal discs, relaxes the lumbar spine, and improves blood circulation — making every session as restorative as it is comfortable. Dual motors drive independent backrest and legrest adjustments, allowing guests to find their perfect recline angle at the touch of a button. Built on a natural wood veneer and powder-coated mild steel frame with a single-piece fully electronic top, the Zero Gravity Chair is as considered in its construction as it is in its purpose.



# KEY FEATURES



## Neutral Body Posture & Spinal Health

The Zero Gravity Chair is built on the principle of neutral body posture — the reclined position gently decompresses spinal discs, relaxes the lumbar spine, and improves blood circulation, offering guests a genuinely therapeutic rest with every use.

## Single-Piece Fully Electronic Top

The single-piece electronic top moves as one seamless surface, eliminating gaps or pressure points across the guest's full length — ensuring consistent comfort from head to toe in every position.

## Dual Motor Independent Adjustment

Two independent motors drive the backrest and legrest separately, allowing guests to dial in their perfect recline angle with precision — smooth, quiet, and entirely effortless at the touch of a button.

## Veridura Ultra Soft Upholstery

The Zero Gravity Chair is available in Veridura Ultra Soft Upholstery — exceptionally soft to the touch and built for the demands of daily commercial use, with phthalate-free, antibacterial, and stain-resistant properties as standard.

## FEATURES

Design	Neutral Body Posture — Spinal Decompression & Improved Circulation
Backrest	Electronically Adjustable
Legrest	Electronically Adjustable
Foam Cushion	110 mm mixed layers of different densities for comfortable massage experience

## TECHNICAL SPECIFICATIONS

Length	1040 mm / 40.9 in
Width	760 mm / 29.9 in
Height	1120 mm / 44 in

## ELECTRICAL PARAMETERS

Power in (Mains Power Supply)	100–240V, 50–60Hz, 3A
IPX Rating	IPX6
Operating Temperature	10–40°C
Shock Protection:	Class I

## BASE & FRAME

Base	Natural Wood Veneer & Powder-Coated Mild Steel Frame
Maximum Load	150 kgs

## SAFETY STANDARDS

General Safety Standards	IEC 60601-1
EMI/EMC	IEC 60601-2

## UPHOLSTERY

Type	Veridura Ultra Soft Upholstery	Phthalate-Free Upholstery
Thickness	1 mm	1.01 mm
Tensile Strength	ISO 1421, 869.22 N/ 5 cm	ISO 1421, 804 N/ 5 cm
Colour Options	Cream, Beige, Mouse Grey, Brown, Charcoal Grey	Cream, Beige, Mouse Grey, Brown
Weight	726.7 g / sqmt	732 g / sqmt
Abrasion	ISO 5470-2 = 2,00,000 cycles / min	ISO 5470-2 = 2,00,000 cycles / min

## WARRANTY

Motors	2 years
Frame	5 years



# TECHNICAL DRAWINGS

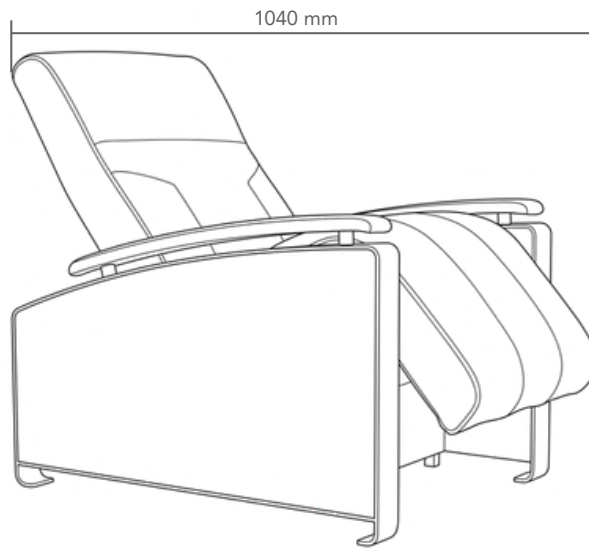

**SIDE VIEW**

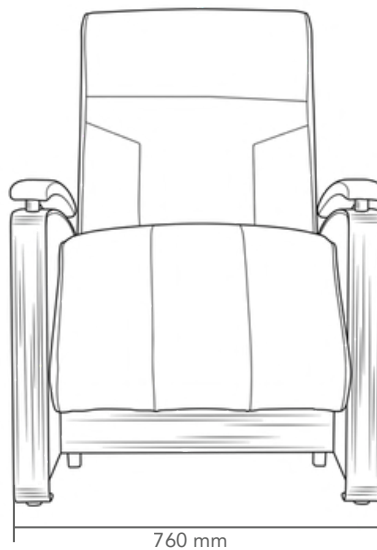

**FRONT VIEW**

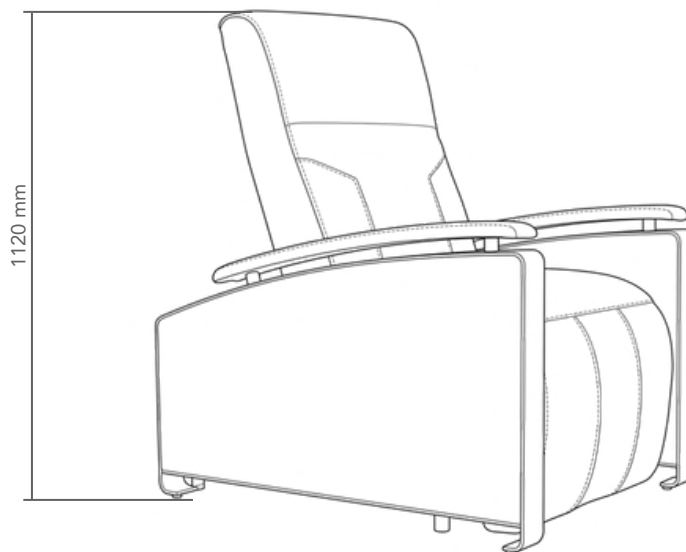

**SIDE VIEW**

ALL DIMENSIONS ARE IN MM

## WOOD FINISH OPTIONS

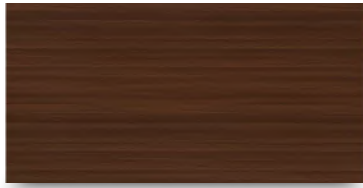

American Oak  
Dark Walnut



American Oak  
Wenge

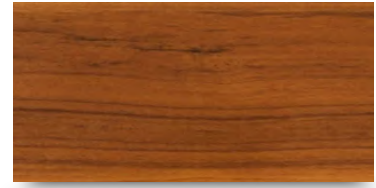

American Oak  
Yellow Teak



American Oak  
White Wash Finish



American Oak  
Water Base



American Oak  
PU Finish

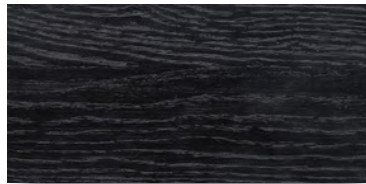

American Oak  
Open Pore Black

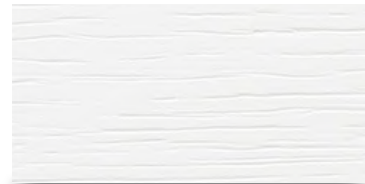

American Oak  
Open Pore White

## VERIDURA ULTRA SOFT UPHOLSTERY

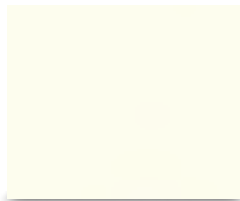

Cream

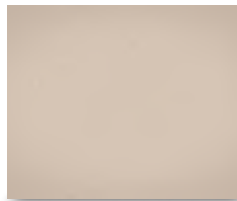

Beige

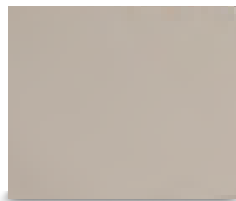

Mouse Grey

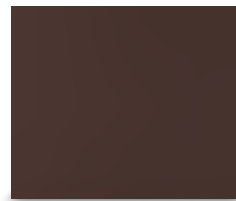

Brown



Charcoal Grey



Phthalate-Free



Fire Retardant



Oil Resistant



Alcohol Resistant



Ultra Soft



Stain Resistant



Anti Bacterial



Eco - Friendly

## PHTHALATE-FREE UPHOLSTERY



Cream

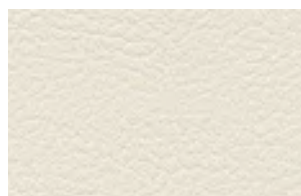

Beige

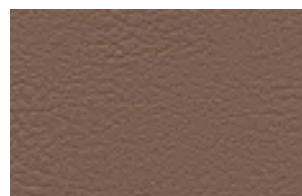

Brown

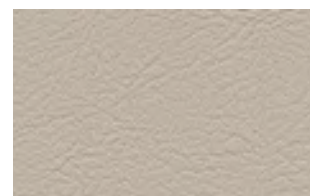

Mouse Grey